



MODELLO NR	F1 (N)	F2 (N)	F3 (N)	F4 (N)	Fi (N)	Vn (dm ³)	ANGOLO (ANGLE) (± 5 °)	PESO (POIDS) (gr ±%2)	BAR
651 - 2 - H	1200	700	1400	925	300	0,25	90 °	620	6
651 - 3 - H	2000	1400	2500	1560	500	0,51	90 °	985	6
651 - 4 - H	3000	2000	3300	2200	750	1,04	90 °	2100	6
651 - 5 - H	4500	2500	5000	3000	1100	2	90 °	3900	6

F1 - F2: FORZA DI ESERCIZIO (FORCE EXERCICEE) , F3 - F4 : CAPACITA' DI TENUTA (CAPACITE DE MAINTIEN) , Fi : FORZA APPLICATA (FORCE APPLIQUEE)

Vn = CONSUMO D'ARIA PER DOPPIA CORSA IN dm3 A 6 BAR. (Vn = consommation d'air aller retour à 6 bar)

Base Verticale Con Manopola

Corps Avec Base de Montage Verticale Avec Poignée

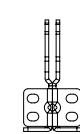
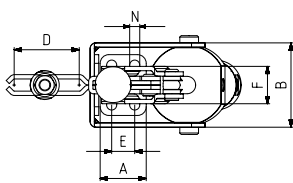
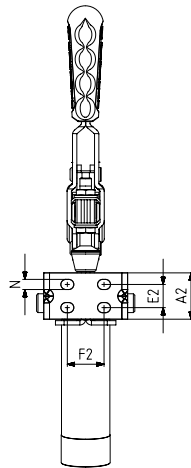
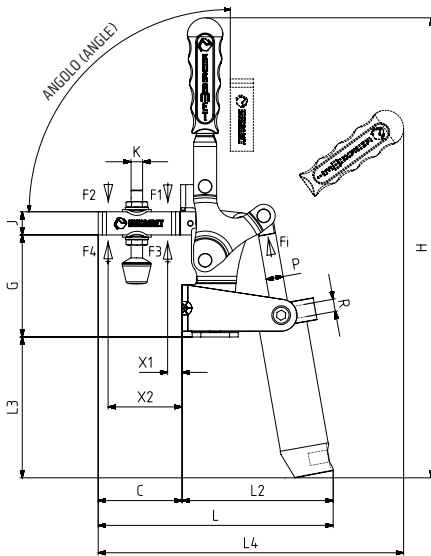

MODELLO NR (N° MODELE) : 651-2-H

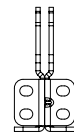

MODELLO NR (N° MODELE) : 651-3-H

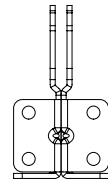

MODELLO NR (N° MODELE) : 651-4-H

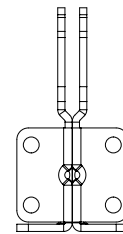

MODELLO NR (N° MODELE) : 651-5-H



- 652
Pagina/Page: 77
- 251
Pagina/Page: 38
- 651
Pagina/Page: 75

Cilindro pneumatico a doppia azione: magnetico e con ammortizzatore
Vérin à double effet : magnétique et avec amortisseur

MODELLO NR	A	A2	B	C	D	E	E2	F	F2	G	H	J	K	L	L2	L3	L4	N	X1	X2	P	R	PISTON Ø
651 - 2 - H	26	26	51	54	42	12,5	12,5	27	27	65	261	13	M6	146	92	82	174	6x8	12	42	Ø 10	G1/8	25
651 - 3 - H	32	32	60	57	42	16	16	25,5	25,5	70,5	318	16	M8	164	106	98	212	7x9	15	42	Ø 12	G1/8	32
651 - 4 - H	50	50	79	89	67	32	32	45	45	100	393	20	M10	230	141	101	287	9	22	70	Ø 16	G1/8	40
651 - 5 - H	65	65	91	113	94	41,5	41,5	57	57	130	447	25	M12	286	172	114	333	11	25	91	Ø 20	G1/8	50